

Digital Fuel Meter

FM-20



Congratulations on purchase of this World Class Digital Fuel Meter!

- Digital turbine meter designed to measure the flow of low viscosity fluids
- Easy installation, both for in-line as well as end of line applications
- Polypropylene Turbine measuring mechanism
- Electronic Display powered by two AAA 1.5 V batteries
- Display can be rotated in four different positions
- Polyamide body and sealed electronic card makes it suitable for use in severe weather conditions
- Features a non-volatile memory for storing the dispensing data, in the event of a complete power break for long periods
- Measures in Litres, Quarts, Pints & Gallons
- Easy user recalibration
- Includes one additional stainless steel adaptor to convert from 1" male to 1" female threads



PART DESCRIPTION

REFERENCE NUMBER	DESCRIPTION	QUANTITY
1	Meter	1
2	Adaptor	1

SPECIFICATIONS

Meter Type	Digital
Meter Mechanism	Turbine
Inlet / Outlet Position	In-Line
Inlet / Outlet	1" (M) both sides or 1" (M) & 1" (F)
Threads	BSP or NPT
Flow Rate	5 to 120 LPM (1.3 to 32 GPM)
Accuracy	+/- 1%
Repeatability	+/- 0.30 %
Max. Working Pressure	300 PSI (20 BAR)
Burst Pressure	580 PSI (40 BAR)
Pressure Loss at 60 LPM (16 GPM) with Diesel	0.50 PSI (0.04 BAR)
Working Temperature Range	-10° C to +50° C (14° F to 122° F)
Pressure loss (at 60 L /min with Diesel)	0.5 PSI (0.04 BAR)
Max Resettable Batch Total	99999 Units
Max Non Resettable Totalizer	9,99,999 Units
Least Count/ Resolution	0.001 Unit
Filter/ Screen Included	No
Max. Viscosity of Media	5.35 cSt
Option to Recalibrate by User	Yes
No. of positions in which the display can be rotated	4
Protective Shroud on Meter	YES
Weights & Measures Approved	NO
Calibration Certificate Included	NO
Water resistance	IP55
CE Listed	YES
For use with Electric Fuel Pumps	YES
For use with Gravity Flow	YES (Minimum 4 feet head is required)
Power supply	2 x 1.5 Alkaline batteries (Size AAA)

RECOMMENDED USE

Diesel, Gasoline, Bio-Diesel, Windshield Fluid, Water

DO NOT USE WITH

Oils

WETTED COMPONENTS

Polyamide, Polypropylene, Viton



In order to improve the life of the turbine, it is recommended to fit a filter before the meter itself.

INSTALLATION

The meter can be installed in any position - fixed in line or mobile on a control nozzle.

How to rotate the display

1. Remove the four screws (2) and separate the card housing (5) from the turbine assembly (6).
2. Rotate the card housing in any of the four positions as shown in the picture and tighten the card housing with four screws (2)

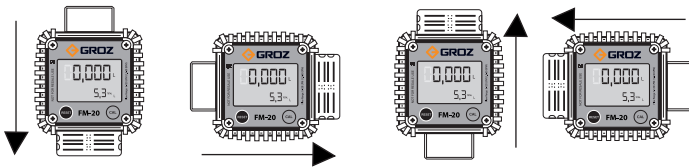

KNOW ABOUT YOUR FLOW METER

Table of Contents

- Component List & Exploded View
- Major Components
- Measurement Units Configuration
- Normal Dispensing Mode
- Resetting The Batch Total
- Resetting The Reset Total
- Dispensing with Flow Rate Mode display
- Calibration
- Calibration Procedures –
 - In-Field Calibration Sequence,
 - Direct Calibration Sequence

A. COMPONENT LIST & EXPLODED VIEW

Sl. No.	Component List
1	Meter Label
2	Screw (Nos. 4)
3	Display with Microprocessor
4	Rubber Shroud
5	Card Housing
6	Turbine Assembly (as a Single Unit)
7	Batteries
8	Battery Cap
9	Screw (Nos. 4)

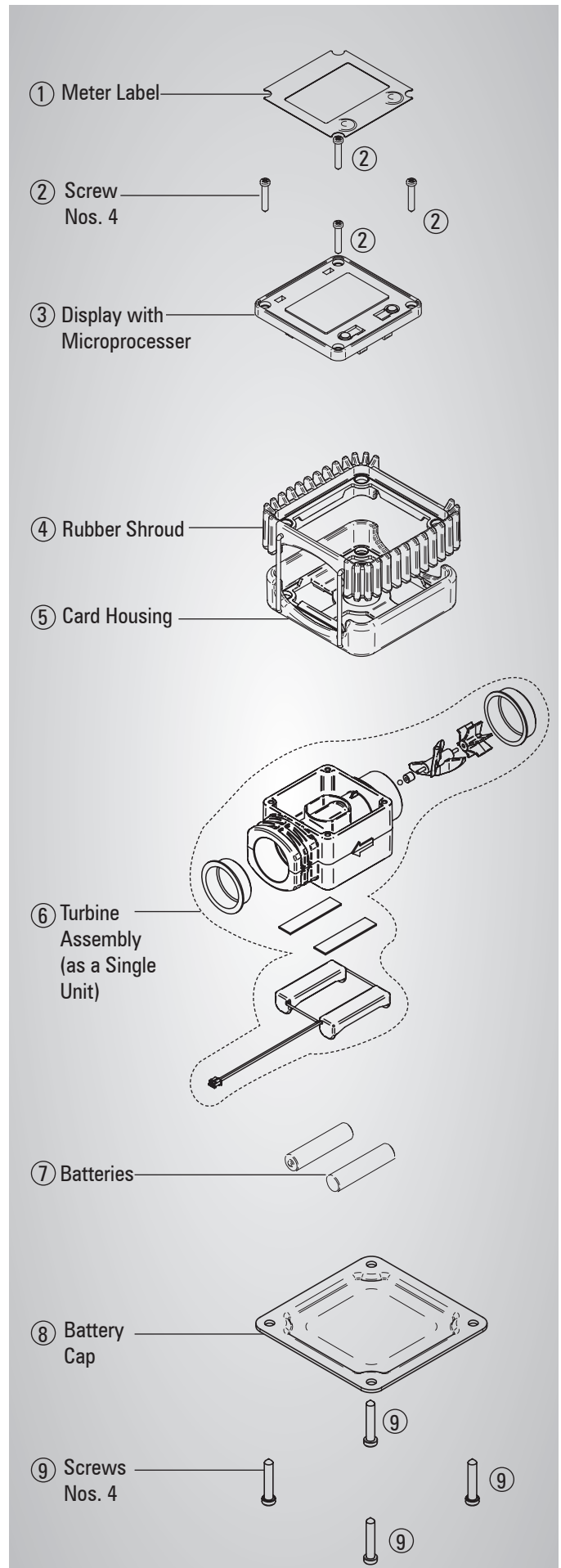

B. MAJOR COMPONENTS

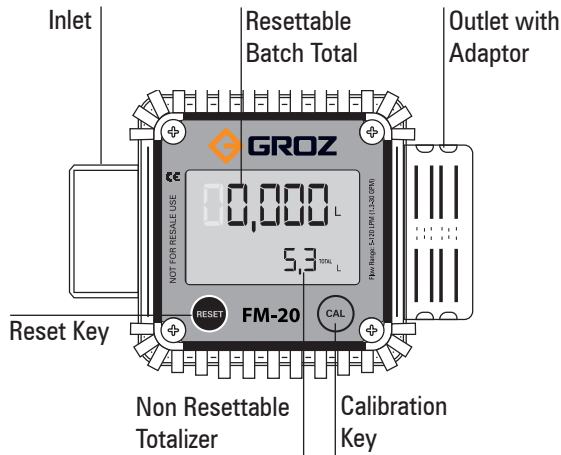

LCD DISPLAY - Powered by two alkaline batteries of 1.5 V each. Includes three numerical Totals and other keys as given below:

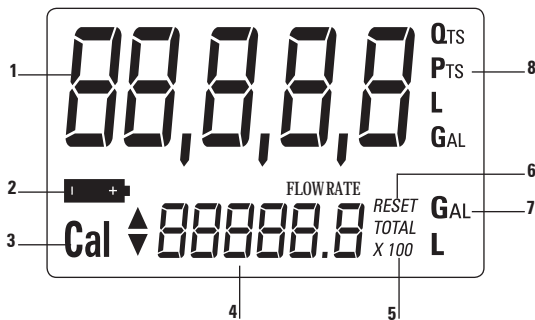

- 1. Resettable Batch Total (5 figures with moving comma)-** indicates volume dispensed after RESET button was last pressed.
- Indication of battery charge.
- Indication of calibration mode.
- 4. Batch Totalizer (6 figures with moving comma in multiple of 10 & 100) -** indicates two types of Total:
 - Non-Resettable General Total (TOTAL)
 - Resettable total (Reset TOTAL)
- Indication of total multiplication factor (x10 or x100).
- Indication of type of total, (TOTAL / Reset TOTAL).
- Indication of unit of measurement of Totalizer:
 - L=Litres
 - Gal=Gallons
- Indication of unit of measurement of Resettable Batch Total:
 - Qts=Quarts
 - Pts=Pints
 - L=Litres
 - Gal=Gallons

User Buttons - The meter features two buttons (RESET and CAL) which individually perform two main functions and together, other secondary functions.

- **RESET key** - is used to reset the Batch Total and Reset Total
- **CAL key** - is used to enter calibration mode
- **Combination of RESET + CAL keys** - is used to change the unit of measurement

Turbine Assembly - It has a threaded inlet and outlet, indicated by an arrow on the outer body. It contains a turbine which turns when media passes through it with sufficient pressure. This action generates electrical pulses which are processed by a microprocessor and the result is displayed on the Totals of LCD.

WHAT IS STANDBY ?

When the media is not flowing through the meter, the meter shows only the word TOTAL on the display. This mode is called STANDBY and majority of adjustments are carried out in this mode.

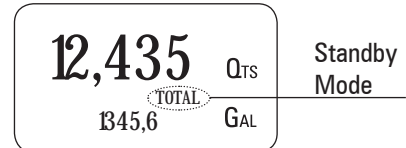

C. MEASUREMENT UNITS CONFIGURATION

The user can select the main measurement unit, Quarts (Qts), Pints (Pts), Litres (L), Gallons (Gal); according to the following predefined combinations:

Reference No	Unit of Measurement Batch Total	Unit of Measurement Total Register
1	Litres (L)	Litres (L)
2	Gallon (Gal)	Gallon (Gal)
3	Quarts (Qts)	Gallon (Gal)
4	Pints (Pts)	Gallon (Gal)

SEQUENCE OF SETTING THE UNIT OF MEASUREMENT

1. Wait for the METER to go to Standby Mode.

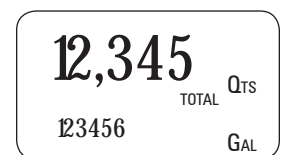

2. Press the CAL and RESET keys together. Keep these pressed until the word "UNIT" appears on the screen together with the current unit of measurement.



3. Press RESET key to scroll among the four combinations of units of measurement as shown :

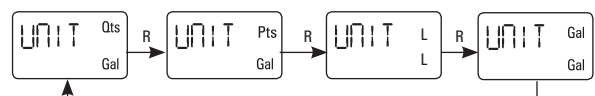

- Press CAL key for more than 2 seconds to store the new settings. The METER will pass through the start cycle and come back to the Stand by Mode.No new calibration is required after changing the Unit of Measurement.

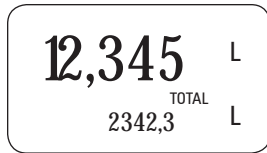

- The display screen again shows all the segments of the display followed by all the switched-off segments and finally shows the display page where the new Reset Total is shown.

D. NORMAL DISPENSING MODE

While the media is flowing through the meter, Batch Total and Reset Total are displayed at the same time.

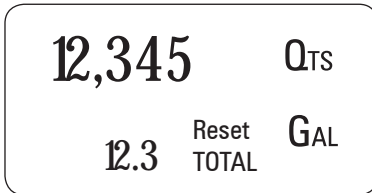

A few seconds after dispensing has ended, on the lower Total, the display switches from Reset Total to General Total: the word RESET above the word TOTAL disappears, and the Reset Total is replaced by the General Total.

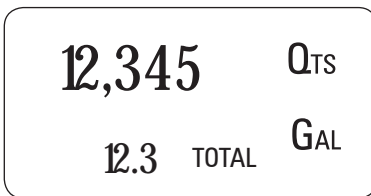

This situation , where only "TOTAL" is displayed, is called **STANDBY mode**. It remains stable until the user operates the meter again.

E. RESETTING THE BATCH TOTAL

- While in standby (i.e when the display shows TOTAL), press the RESET button.
- During reset, the display screen first of all shows all the lit-up digits and then all the switched off digits.
- At the end of the process, a display page is first of all shown with the reset batch and the Reset TOTAL
- After a few moments, the Reset TOTAL is replaced by TOTAL.

F. RESETTING THE RESET TOTAL

The Reset Total can be reset by pressing the RESET key at length while the display screen shows Reset TOTAL. The steps to be taken are:

- Wait until the display shows Total only (standby mode)
- Press the RESET key quickly.
- The meter starts to reset the Batch Total.
- While the display page showing the Reset Total is displayed, press the Reset key again for at least 1 second.

G. DISPENSING WITH FLOW RATE MODE DISPLAY

- In standby mode, press the CAL key and start dispensing the media.
- The display will start showing "FLOW RATE", in place of TOTAL.
- To return to standby mode, stop dispensing & when the flow rate becomes zero, press CAL key once again.

H. CALIBRATION

In standby mode, press the CAL key for more than 2 seconds to see the current calibration factor.

- Factory K Factor: Factory-set default factor. It is equal to 1 (indicated as 1,000).**
- User K Factor: Customized calibration factor, meaning modified by calibration.**

The meter has been calibrated at the factory under the following operating conditions:

Fluid	:	Diesel fuel
Temperature	:	20°C (68° F)
Flow rate	:	10-120 litres/min

Calibration is needed to make the meter suitable for actual conditions.

I. CALIBRATION PROCEDURES

- In-Field Calibration
- Direct Calibration

By pressing the CAL key while the meter is in Standby, the display shows the current calibration factor used. Two cases can occur:

CASE 1:

If no calibration has ever been performed, or the factory setting has been restored after previous calibrations, the following display page will appear:



The word "Fact" abbreviation for "factory" shows that the factory calibration factor is being used.

CASE 2:

If, on the other hand, calibrations have been made by the user, the display page will appear showing the currently used calibration factor (in our example 0,998) .

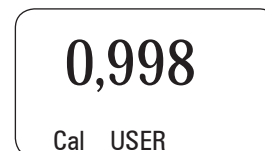

The word "user" indicates that a calibration factor, set by the user is being used.

To confirm the choice of calibration factor, quickly press CAL while "User" or "Fact" are displayed. After the restart cycle, the meter uses the calibration factor that has just been confirmed

IN-FIELD CALIBRATION SEQUENCE

1. Wait until the METER comes in Standby (Display shows TOTAL).

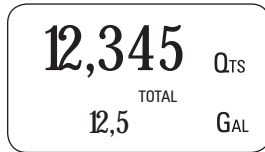

2. Press CAL key for more than 2 seconds. The METER enters calibration mode and shows "CAL". The words "FACT" and "USER" indicate which factor (factory or user) is currently in use.



OR

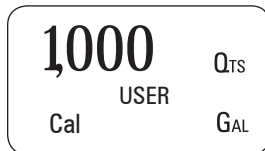

3. Press RESET key for more than 2 seconds. The METER shows "FIELD" and the Batch Total at zero. The meter is ready to perform in-field calibration.

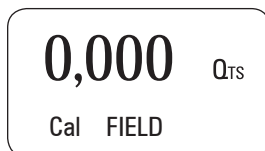

4. DISPENSING INTO SAMPLE CONTAINER

Without pressing any key, start dispensing into the sample container.

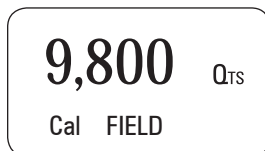

Dispensing can be interrupted and started again at will. Continue dispensing until the level of the fluid in the sample container has reached the graduated area. There is no need to reach a preset quantity.

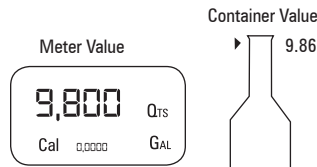

5. Press RESET key once. The METER detects that the calibration dispensing is finished. An arrow (up/down) appears which indicates the direction in which the value can be changed via steps 6 & 7. To calibrate the METER, the value indicated by the Batch total (example 9.800) must be forced to the Container value marked on the graduated sample container.

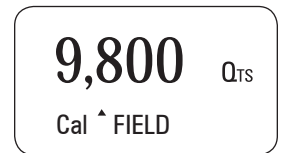

6. Press RESET key once. The arrow changes direction. The operation can be repeated to alternate the direction of the arrow.

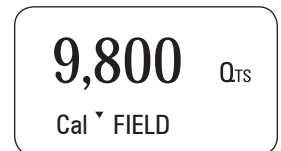

7. Press "CAL" key to change the value in the direction indicated by the arrow. The reading changes
 - by one unit for every short press of CAL key.
 - continually if the CAL key is kept pressed.

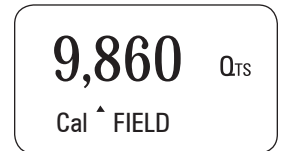

8. Press RESET key for more than 2 seconds. The METER is informed that the calibration procedure is finished. The meter calculates the new USER K FACTOR factor for a few seconds.

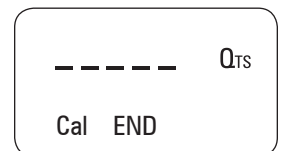

9. The new USER K FACTOR is shown for a few seconds, after which the restart cycle is repeated to finally achieve standby condition.



10. The METER stores the new calibration factor and is ready to begin dispensing.

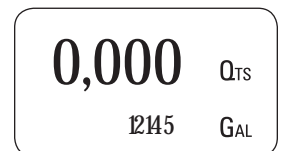

DIRECT CALIBRATION SEQUENCE

If normal METER operation shows a **mean percentage error E**, (obtainable on the basis of several performed dispensing operations), this can be corrected by applying a correction to the **current calibration factor** as shown below :-

$$\text{New cal. Factor} = \text{Old Cal Factor} \times \left\{ \frac{100 - E}{100} \right\}$$

Example:

Error percentage found E% = - 0.3 %
 CURRENT calibration factor = 1.000
 New USER K FACTOR = $1.000 * [(100 - (- 0.3))/100]$
 = $1.000 * [(100 + 0.3)/100]$
 = 1.003

1. Wait until the METER comes in Standby (Display shows TOTAL).

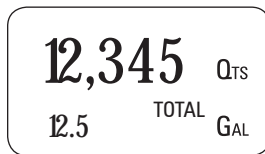

2. Press CAL key for more than 2 seconds. The METER enters calibration mode and shows "CAL". The words "Fact" and "USER" indicate which factor (factory or user) is currently in use.

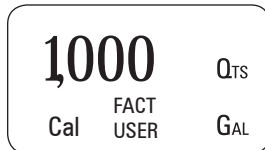

3. Press RESET key for more than 2 seconds. The METER shows "CAL" and the Batch Total at zero. The meter is ready to perform in-field calibration.



4. Press RESET key for more than 2 seconds. "Direct" appears together with the Current calibration factor. In the bottom left part of the display, an arrow appears (upwards or downwards) defining the direction (increase or decrease) of the reading.

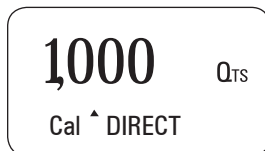

5. By pressing RESET key the user can change the direction of the arrow.



6. By pressing CAL key, the Meter value changes in the direction indicated by the arrow,
- one unit for every short press of CAL key .
 - continually if the CAL key is kept pressed. The speed increase rises by keeping the key pressed.

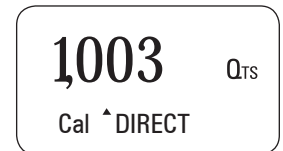

7. Press RESET key for more than 2 seconds. The METER detects that the desired reading has been set and the calibration procedure is finished.

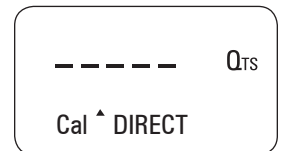

8. At the end of the calculation, the new USER K FACTOR is shown for a few seconds.

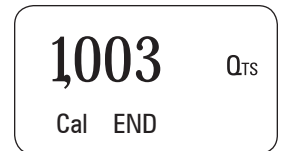

9. The restart cycle is repeated to finally achieve standby mode.

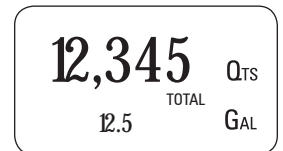

MAINTENANCE

The Meter has been designed to require a minimum amount of maintenance.

The only maintenance jobs required are:

- **Battery change** - Necessary when the batteries have run down
- **Cleaning the turbine assembly** - Due to the presence of solid particles following bad filtering.

CHANGING THE BATTERY

The METER features two low-battery alarm levels

1. When the battery charge falls below the first level on the LCD, the fixed battery symbol appears. In this condition, the METER continues to operate correctly, but the fixed icon warns the user that it is time to change the batteries.

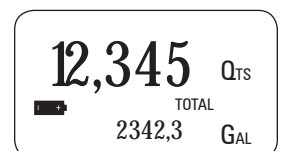

2. If meter operation continues without changing the batteries, the second battery alarm level will be reached which will prevent operation. In this condition the battery icon starts to flash and is the only one to remain visible on the LCD.

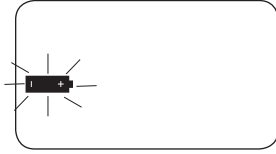

BATTERY REPLACEMENT PROCEDURE :

- Press RESET to update all the totals
- Remove the four screws (9) and separate the battery cap (8).
- Remove the old batteries.
- Place the new batteries in the same position as the old ones, making sure the positive pole is positioned as indicated.
- Re-tighten the battery cap.
- The METER will switch on automatically and normal operation can be resumed. The old calibration will stay same as before..

CLEANING OF THE TURBINE ASSEMBLY

After removing the meter from pipes, any residual elements can be removed from the turbine by simply washing it with water.



Always make sure the liquid has been drained from the meter and the line pressure is released before cleaning.

Never use compressed air for cleaning as it may damage the turbine assembly.

TROUBLESHOOTING

Problem	Possible Cause	Corrective Action
No indication on display	Bad battery contact	Check battery contacts
Inaccurate measurement	Wrong Calibration	Follow CALIBRATION procedure
Reduced or zero flow rate	TURBINE blocked	Clean the TURBINE
The meter does not count, but the flow rate is correct	Incorrect installation of the card	Reinstall the card
	Possible electronic card problems	Contact your dealer



**Groz Engineering Tools (P) Ltd.
Groz Net Industries**

Village Kherki Daula, National Highway-8
Gurgaon-122001, Haryana, INDIA
TEL +91.124.282.7700 / 221.4050
FAX +91.124.2827986 / 221.4224
FAX (USA) +1.509.271.7848
FAX (UK) +44.870.121.1854

E-MAIL info@groz-tools.com
URL www.groz-tools.com

The Groz name, Groz logo and the  mark are trademarks of Groz Engineering Tools (P) Ltd. India